

Pecyn
Gweithgareddau
Ysgol Gymraeg
Casnewydd
Activity Pack



Meithrin / Nursery
Wythnos 3 / Week 3
13.07.2020

Dosbarth: Meithrin		Thema: Gorau Cam, Cam Cyntaf / Every Journey Begins with a Single Step – Pobl sy'n Helpu / People who help (Diffodwyr Tân / Fire Fighters) Week 3	
leithoedd, Llythrennedd a Chyfathrebu / Languages Literacy and Communication		Arloesi / Innovation	
<p>Task 1 / Task 1</p> <p>Darllenwch y Pwyntpwyr Beth mae Diffodwyr Tân yn eu wneud? Trafodwch ei cynnwys ac ail-ddarlennwch rhai o'r geiriau cymraeg, yn dod i adnabod rhai o'r llythrennau.</p> <p>Read the PowerPoint What do Firefighters do? Discuss its content and read some of the Welsh words a few times, learning letter recognition.</p>	<p>Task 1 / Task 1</p> <p>Creu Injan Dŵn neu Diffodwyr Tân allan o Lego neu blociau. Trafodwch y siapiau (cylch, sgwâr, triongol, petryal) a'r lliwiau wrth wneud. Efallai dechrau son am siapiau 3d hefyd. Cyfrif faint o flociau defnyddioch chi.</p> <p>Create a Fire Engine or a Fire Fighter out of Lego or building blocks. Discuss the shapes (circle, square, triangle, rectangle) and the colours used. Count how many blocks were used. Maybe begin to talk about 3d shapes.</p>	<p>Task 1 / Task 1</p> <p>Creu roced dŵr allan o eitemau ailgylchu. Gallwch ddechymgu lansiô dŵr er mwyn diffodd tân! Dilynwch y tudalen gam wrth gam.</p> <p>Create a homemade water rocket out of recycled items. You could pretend launching the water rocket in order to put out the fire! Use the step by step guide.</p>	<p>Task 1 / Task 1</p> <p>Athrawon newydd! New teachers! Gwiltwch y lincs Youtube i weld eich athrawon newydd yn y Derbyn. Yna creu llun ohonynt a nodwch y pethau rydych chi wedi dysgu amdanynt o amgylch y llun.</p> <p>Watch your new Reception Teachers on the Youtube links. Draw a picture of your teacher and all the things that they like around them.</p> <p>Miss Porter – Pili Pala https://youtu.be/_GiwBIHQYLO Miss Blackmore – Jemima Mop https://youtu.be/yS73LaS8zzA</p>
<p>Task 2 / Task 2</p> <p>Geiriau allweddol / Key Words</p> <p>Darllenwch y llythren cyntaf o'r geiriau a cheiswch cyfateb ffof llun.</p> <p>Read the first letter of the word and try and match it with the picture.</p>	<p>Task 2 / Task 2</p> <p>Llwgio gan ddefnyddio rhifau. Dod i adnabod y rhifau a chwilio amdanynt wrth lliwio. Dod i adnabod a swmio y gair/llw neu'r llythrenau unigol allan wrth ymyl y llw. Beth am greu llun rhifau eich hun? Gallwch greu allwedd eich hun yna lleoli'r rhifau o few y llun.</p> <p>Colour by numbers. Recognise the numbers as you search for them. Recognise the number and sound the colour/word or the individual letters out that are next to the letter in the Key. You could create your own picture with numbers with a new Key and colour choices.</p>	<p>Task 2 / Task 2</p> <p>lechyd a Lles / Health and Well-being</p> <p>Ras cyfnewid Achub / Fire Fighter Relay Rescue</p> <p>Creu ras rwystrau efo tegau ar y diwedd. Rhaid rhedeg ar hyd, trwy ac ar draws y rwystrau er mwyn achub y tegau ar ddiwedd y ras. Efallai gallwch amseru eich hun, neu rasio yn erbyn rhywun.</p> <p>Create an obstacle race with a toy placed at the end. You will need to run along, over, through the obstacles in order to rescue the toy. Maybe you could time yourself or race against someone.</p>	<p>Task 2 / Task 2</p> <p>lechyd a Lles / Health and Well-being</p> <p>Ras cyfnewid Achub / Fire Fighter Relay Rescue</p> <p>Creu ras rwystrau efo tegau ar y diwedd. Rhaid rhedeg ar hyd, trwy ac ar draws y rwystrau er mwyn achub y tegau ar ddiwedd y ras. Efallai gallwch amseru eich hun, neu rasio yn erbyn rhywun.</p> <p>Create an obstacle race with a toy placed at the end. You will need to run along, over, through the obstacles in order to rescue the toy. Maybe you could time yourself or race against someone.</p>
<p>Task 3 / Task 3</p> <p>Ysgrifennwch y llythren cyntaf o'r gair, neu'r gair i gyd, yna darlunwch lun o'r gair. (Max Rocks)</p> <p>Write the first letter of the word, or the whole word, and then draw a picture of the word.</p>	<p>Task 3 / Task 3</p> <p>Defnyddiwch y siapiau a rhoddydd yn y pecyn. Defnyddiwch eich sgiliau siswrn a thori'r llwy allan ac yna creu Diffodwyr Tân neu Injan Dŵn. Bydd angen siswrn, glud, siapiau a phapur A4.</p> <p>Use the shapes provided in the booklet. Use your scissor skills to cut out the shapes and create a Fire Fighter or Fire Engine. You will need a scissors, glue, shapes and A4 paper.</p>	<p>Task 3 / Task 3</p> <p>Edrychwch trwy eich bocs ailgylchu. Oes eitemau yna gallwch ddefnyddio er mwyn creu Injan Dŵn? Beth yw enwau'r defnyddiau a defnyddiwyd? Plastic, papur, cerdyn, metal, glud, paint?</p> <p>Look through your recycling box. Are there any items in there that you could use to create a Fire Engine? What are the names of the materials used? Plastic, paper, card, metal, glue, paint?</p>	<p>Task 3 / Task 3</p> <p>Human-bach / Self-Esteem</p> <p>Rwy'n falch o fi fy hun oherwydd... Trafodwch y gair 'balch'. Llenwch y tablenn dros wythnos, un pob dydd.</p> <p>I'm proud of myself because... Discuss the meaning of the word 'proud'. Fill in the sheet provided over a week. One thing each day.</p> <p>Tafleoni llwio – Beth am roi bach o gerddoriaeth ymlaen i ymlacio wrth llwio. Colouring sheets – Why not put some relaxing music on in the background while you colour.</p>

Dewch i gwrdd a dysgu mwy am
eich a'ch athrawon newydd!

Bydd y fideos hyn ar gael i'w gweld ar 13.07 ar ôl 13:30 / These videos will be
available to view on 13.07 after 13:30

Pili Pala

[https://www.youtube.com/watch?v= GiwB1H
qYL0&list=PLkFGluKuwSUSrdCmYnY11m3f1xP
MVPIIx&index=12&t=2s](https://www.youtube.com/watch?v=GiwB1HqYL0&list=PLkFGluKuwSUSrdCmYnY11m3f1xPMVPIIx&index=12&t=2s)

Jemima Mop

<https://youtu.be/yS73LaS8zza>

Ymarfer llawysgrifennu

Handwriting practice

Ymarferwch eich llawysgrifen yna lliwio y llun.
Practice your handwriting then colour the picture.

t



tân

tân

i

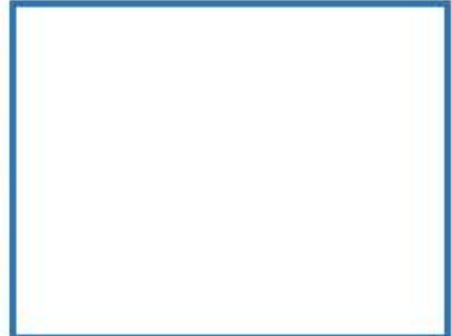

injan dân

injan dân

g



gorsaf

gorsaf

Ymarfer llawysgrifennu

Handwriting practice

Ymarferwch eich llawysgrifen yna lliwio y llun.
Practice your handwriting then colour the picture.

g



gwisg

gwisg

h



het

het

r

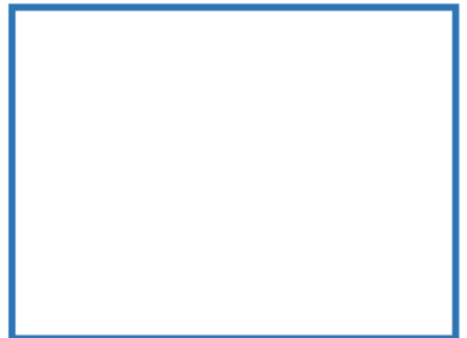

radio

radio

Iaith / Literacy

Tasg 3 / Task 3



cryf

(strong)



pibell

(hose)



helmed

(helmet)



injan dân

(fire engine)



mwgwd

(mask)

Iaith / Literacy

Tasg 3 / Task 3



tân

(fire)



gorsaf

(station)



gwisg

(uniform)

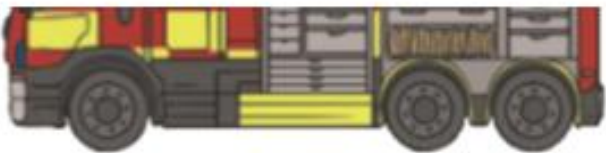

olwyn

(wheel)

Rhifedd / Numeracy

Tasg 2 / Task 2



1. brown brown	4. gwyrdd tywyll dark green	7. oren tywyll dark orange	10. porffor purple
2. oren orange	5. gwyrdd golau light green	8. gwyn white	11. glas golau light blue
3. melyn yellow	6. du black	9. lliw croen skin tone	2. glas tywyll dark blue

Rhifedd / Numeracy

Tasg 2 / Task 2

Creu un eich hun
Create your own

Allwedd
Key



1.	<u>coch</u> / red
2.	

Rhifedd / Numeracy

Tasg 2 / Task 2

Creu un eich hun
Create your own

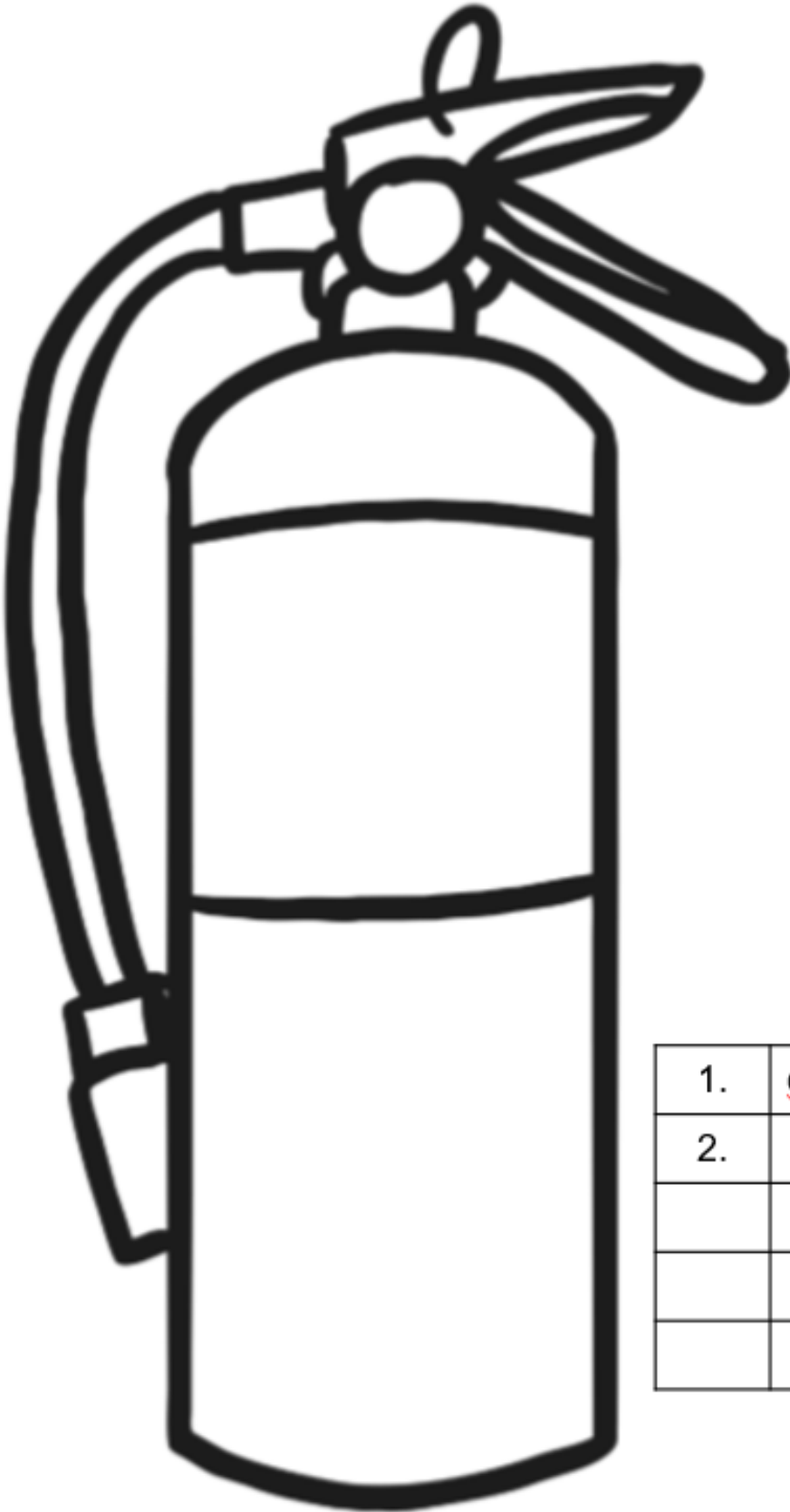

Allwedd
Key

1.	<u>coch</u> / red
2.	

Rhifedd / Numeracy

Tasg 2 / Task 2

Creu un eich hun
Create your own

Allwedd
Key

1.	<u>coch</u> / red
2.	



Rhifedd / Numeracy

Tasg 2 / Task 2

Creu un eich hun
Create your own

Allwedd
Key

1.	<u>coch</u> / red
2.	

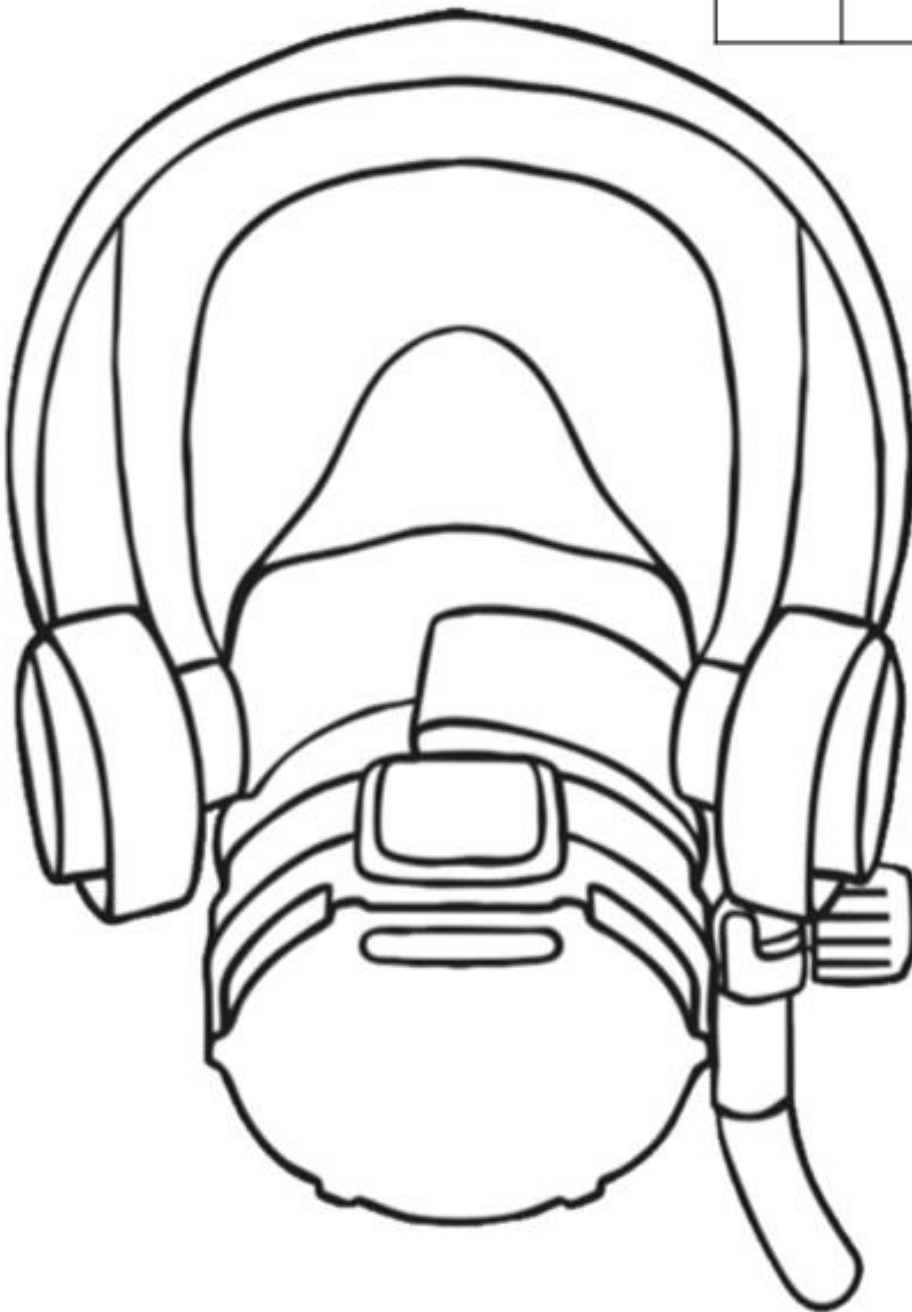

Rhifedd / Numeracy

Tasg 3 / Task 3

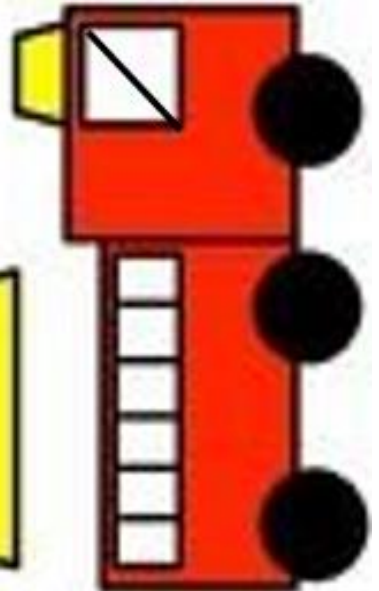
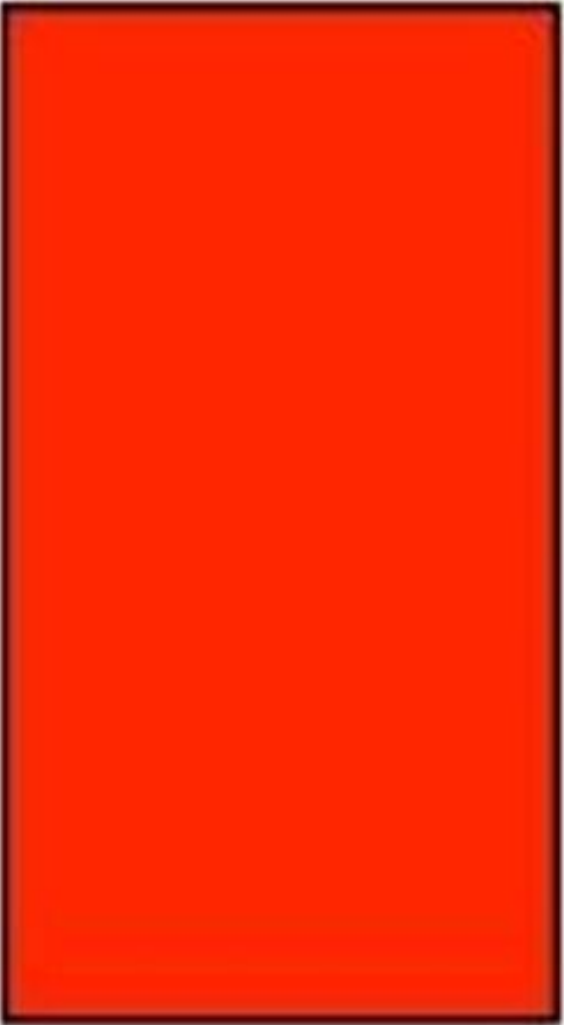

Arloesi / Innovation

Tasg 1 / Task 1



Bydd angen: potel plastig, côn papur a 2 triongl wedi neud allan o gerdyn. 3 pensil. Corcyn, dwr a phwmp beic.

Gather your materials: plastic water bottle, a paper cone, and two paper or cardboard triangles. 3 pencils to make a stand. Cork, water, and a bicycle pump to pressurize the bottle.



Rhowch y con papur ar ben y roced (gwaelod y potel). Gludwch y trionglau cerdyn i bob yn ochr y potel, tua hanner ffordd lan.

Tape a paper cone to the top of the rocket (the bottom of the bottle). Tape paper or cardboard triangles on either side of the bottle, roughly halfway up the bottle.

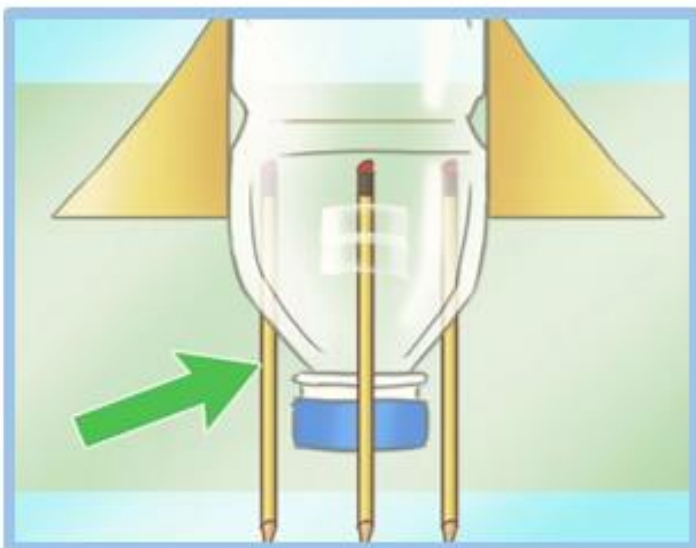

Adeiladwch Sylfaen ar gyfer eich roced. Rhowch bensiliau o amylch y potel. Sicrhewch fod y pensiliau yn pwyntio i lawr.

Build a rocket stand. Tape pencils around the sides of the bottle to make a stand. Make sure that the pencils are pointing down.

Arloesi / Innovation

Tasg 1 / Task 1



Rhowch ddwr yn potel. Tua hanner ffordd lan.

Put water in the bottle. You should fill the bottle half full of water.

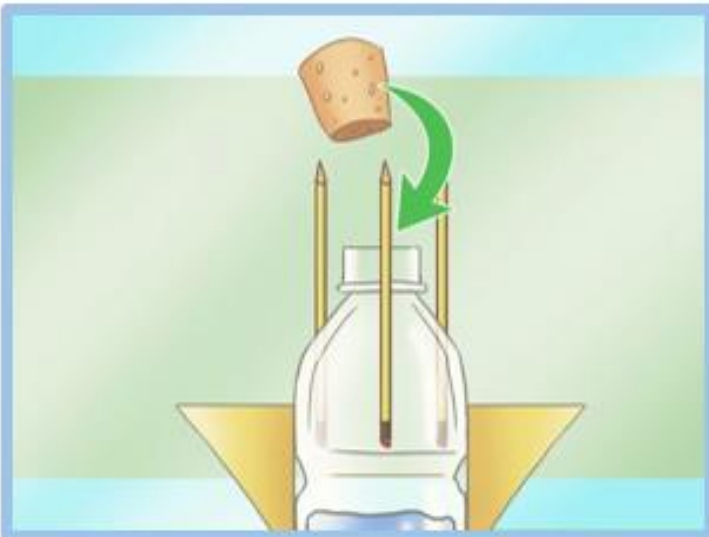

Newidwch y caead gwreithiol efo corcyn. Bydd y corcyn yn sicrhau gwasgedd. Bydd y corcyn yn dod allan a bydd y roced yn hedfan gan wasgaru'r dwr.

Replace the original cap with a cork that fits into the opening of the bottle. The cork will allow pressure to build inside the bottle. The cork will also pop out allowing the contents to shoot out.

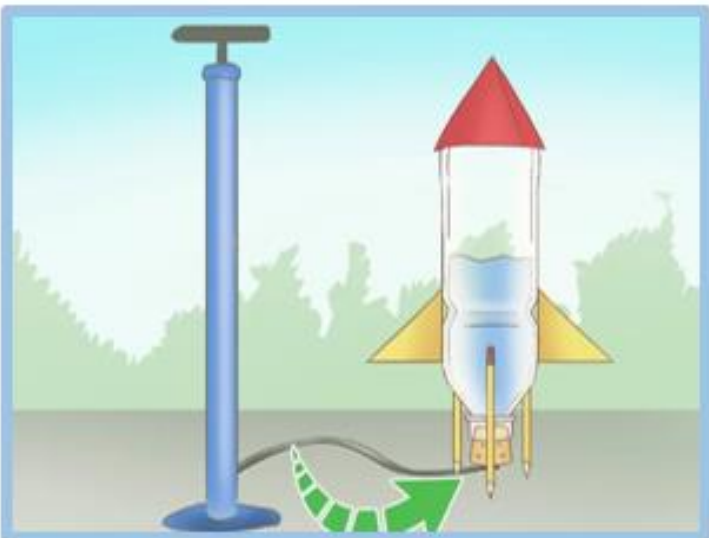

Pwmpiwch aer mewn i'r potel. Defnyddiwch pwmp beic. Rhowch nodwydd y pwmp mewn trwy'r corcyn, yna pwmpiwch.

Pump air into the bottle. Use a bicycle pump with a needle. Insert the needle into the bottle through the cork and pump.

Helmed Plât Papur Diffoddwyr Tân Paper Plate Fire Fighters Helmet



Bydd angen:
You will need:

- Plat papur / Paper plate
- Cerdyn / Card
- Paint / Paint
- Peniau ffelt / Felt pens
- Siswrn / Scissors
- Pensil / Pencil
- Glud / Glue stick
- Gllud PVA / PVA glue



Helmed Plât Papur Diffoddwyr Tân

Bydd angen:
You will need:

- Plât papur / Paper plate
- Cerdyn / Card
- Paint / Paint
- Peniau ffelt / Felt pens
- Sîswrn / Scissors
- Pencil / Pencil
- Glud / Glue stick
- Glud PVA / PVA glue



1 Carefully cut out the centre circle of the paper plate without damaging the outer rim. Keep the circle as this will be the front of your helmet.



4 Now design a badge for the front of the hat! Then cut this out.



2 Draw and cut out a shallow semicircle from the card. This will form the rim for the front of the hat.



5 Using the glue stick, attach the badge to the top part of the hat. You may want to draw around the outline of the badge, using a felt-tip pen.



3 Paint both parts of the paper plate, along with the card, then leave to dry.



6 Now attach the top part of the hat to the circular rim. To do this, first cut a small slit in opposite sides of the rim. Then slot the top part of the hat into these and stick in place at an angle.



7 Next stick the semicircle shaped piece of card to the front of the hat using PVA glue.

Arloesi / Innovation

Tasg 3 / Task 3



on box chronicles

Lles / Wellbeing

Tasg 1 / Task 1

Athrawon newydd! ***New teachers!***

Gwiliwch y lincs Youtube i weld eich athrawon newydd yn y Derbyn.

Watch your new Reception Teachers on the Youtube links.

Miss Porter – Pili Pala

https://youtu.be/_GiwB1HqYLO

Miss Blackmore – Jemima Mop

<https://youtu.be/VOVT9bgIJWA>

Lles / Wellbeing

Tasg 3 / Task 3

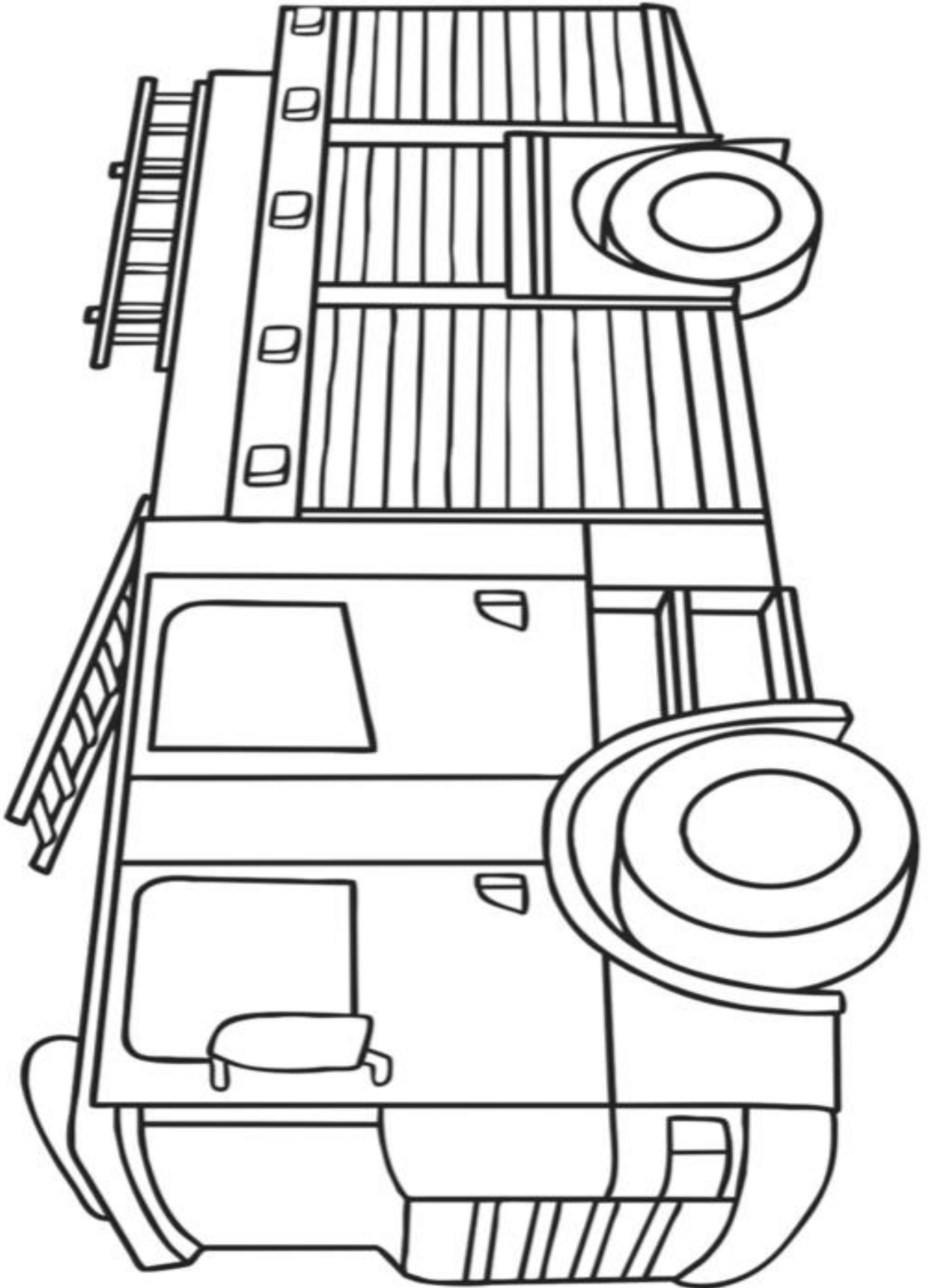

Lles / Wellbeing

Tasg 3 / Task 3

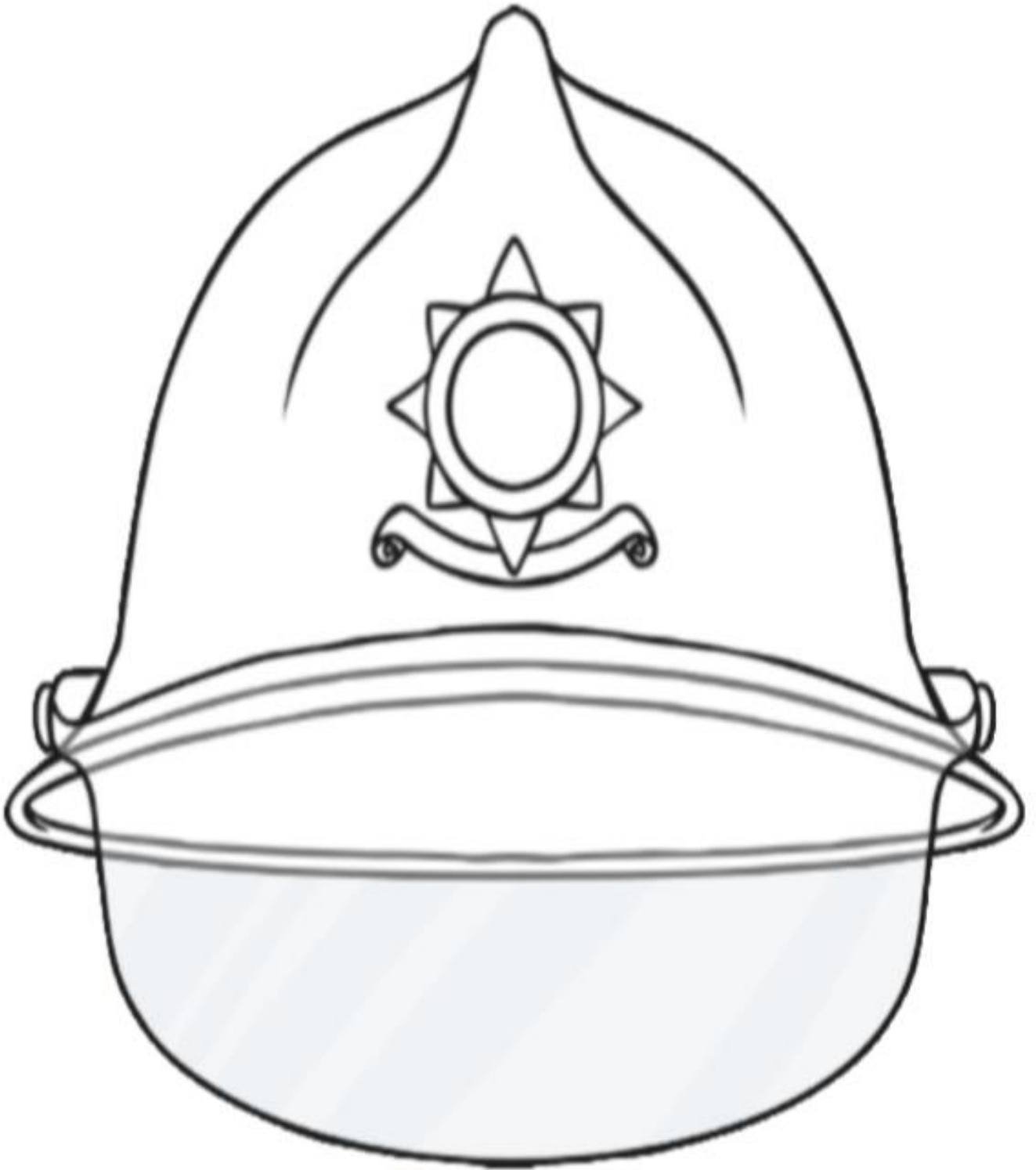

Lles / Wellbeing

Tasg 3 / Task 3



Lles / Wellbeing

Tasg 3 / Task 3



Lies / Wellbeing

Task 3 / Task 3

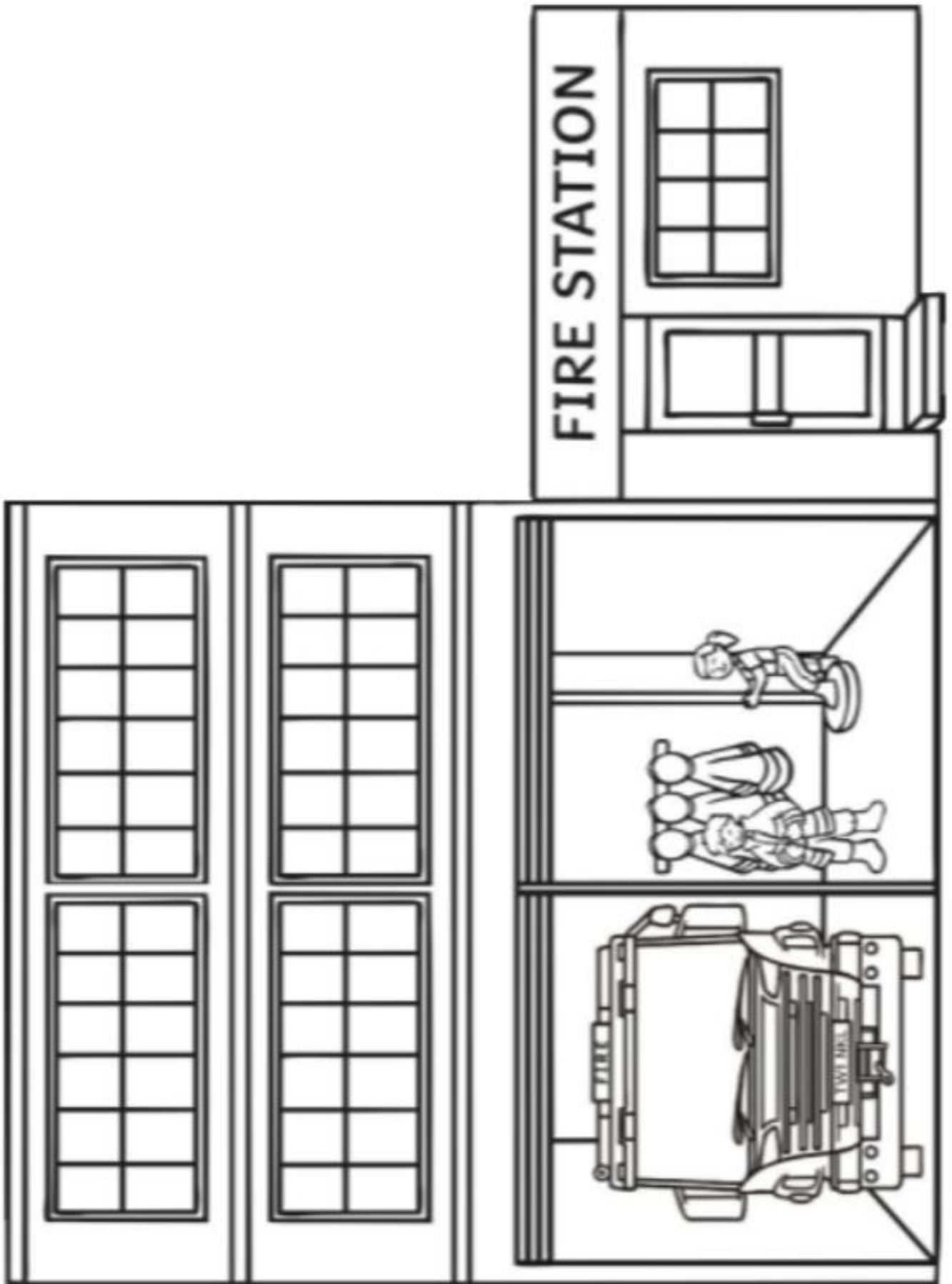

Lles / Wellbeing

Tasg 3 / Task 3



I am proud
of myself for

www.kidfriendly.com



I am proud
of myself for

www.kidfriendly.com



I AM PROUD OF MYSELF FOR

www.kidfriendly.com



I AM PROUD OF MYSELF FOR

www.kidfriendly.com



I AM
PROUD OF
MYSELF
FOR

www.kidfriendly.com



I AM
PROUD OF
MYSELF
FOR

www.kidfriendly.com